

High-Reliability MINIATURE INTERCONNECTS

SHORT FORM CATALOG

**Omnetics
Connector Series
at a Glance –**
Compact, rugged
& proven connector
solutions for critical
environments.



About Omnetics

Omnetics Connector Corporation is a privately held, world class connector design and manufacturing company with over 40 years experience focused on ultra-lightweight micro-miniature and nano-miniature highly reliable electronic connectors and interconnection systems. Our products are designed and assembled in a single location at our plant in Minneapolis, Minnesota that includes in-house automatic machining and over-molding equipment.

Omnetics' Flex Pin

Designed for
High Shock
and Vibration

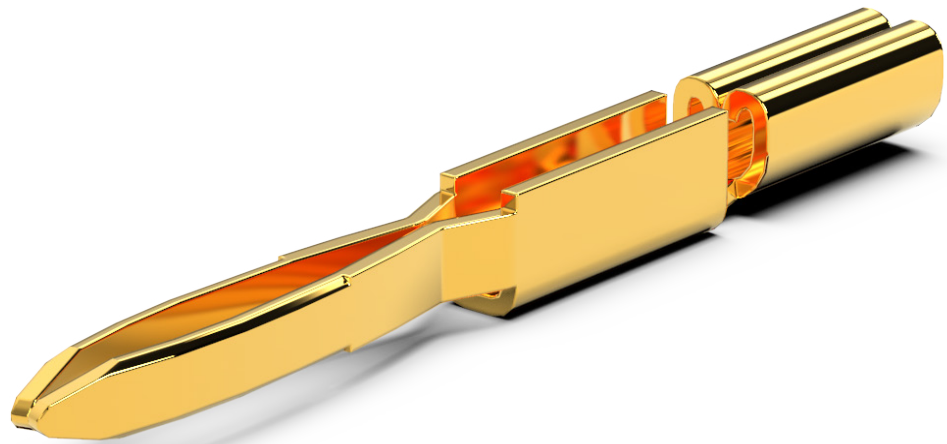

Omnetics' Flex Pin contact design is an engineered piece, designed and produced many years before the creation of MIL-DTL-32139. This simple one piece design is stamped from ASTM B194 BeCu. The spring characteristic of BeCu is ideal for withstanding high shock and vibration situations.

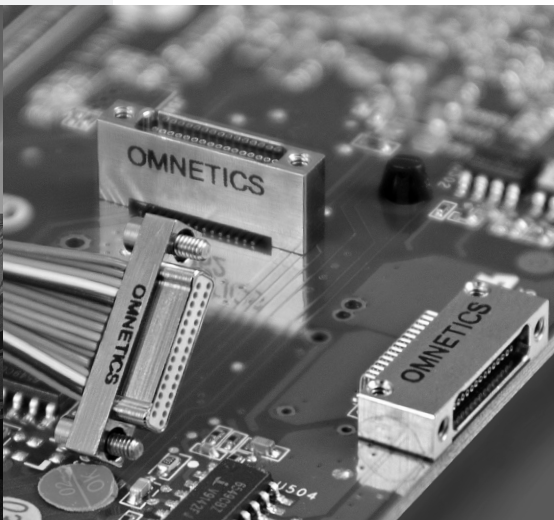
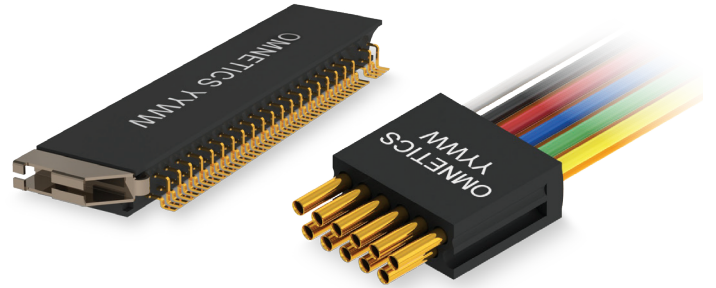

Table Of Contents



Micro 360° Circular Connectors: pages 4-5



Micro Strip Connectors: pages 6-7
Micro Headers: page 7

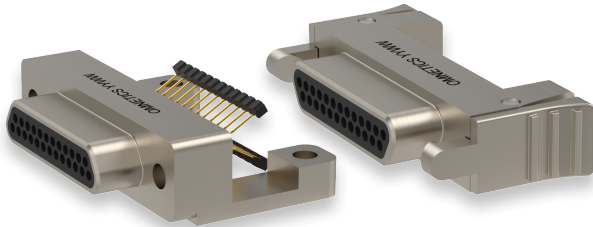

Micro-D Connectors: pages 8-9
USB 3.0: page 9

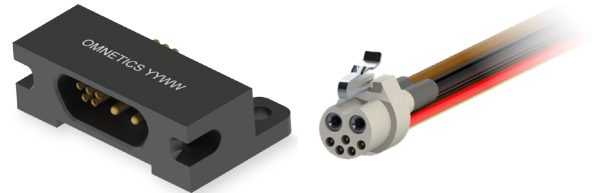

Hybrid Connectors: pages 10-11

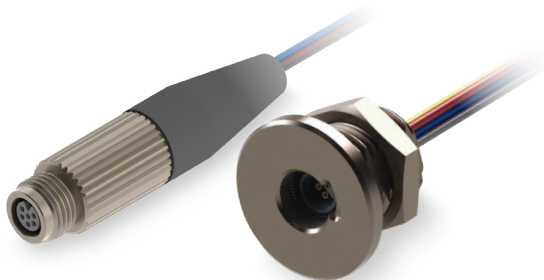

Nano 360° Circular Connectors: pages 12-13

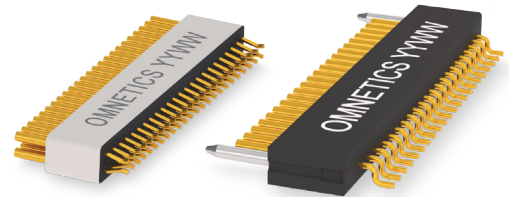

Nano Strip Connectors: pages 14-15
PZN Strip Connectors: page 15
Nano Headers: page 15

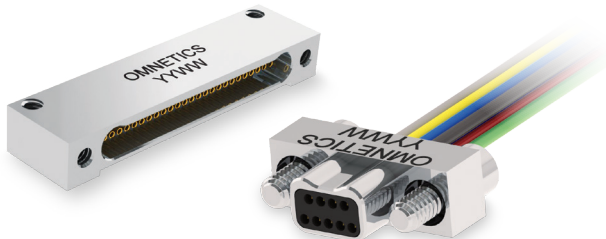

Bi-Lobe® / Nano-D: pages 16-17

OMNETICS
CONNECTOR CORPORATION

Micro 360[®] Circular Connectors

Omnetics Micro 360[®] Circular Series (spaced at .050" / 1.27 mm centerline-to-centerline) is ideal for tight spaces and rugged environments. This family of interconnect solutions features a mated length of less than 12.4 mm.

Both the male (pins) and female (sockets) are shrouded by the plastic insulator which houses the contacts, ensuring the contacts themselves are protected during mating and de-mating. Outer diameters range from 5.6 mm to 11.3 mm.

Whether you are using these connectors housed inside of a metal shell or stand-alone, these high density circulars have the ability to withstand high shock and vibration while maintaining their electrical integrity. Many standard and custom options are available including custom cable harnesses.

Product Specifications

Insulator Sizes:	5 through 39 contacts
Current Carrying:	3 AMPs per contact
Dielectric Withstanding:	600 VAC RMS at sea level
Insulation Resistance:	5000 Megohms min at 500 VDC
Vibration:	20 g's with no discontinuities > 1 microsecond
Shock:	50 g's with no discontinuities > 1 microsecond
Operating Temperature:	-55°C - +200°C
Durability:	Exceeds 2000 mating cycles

Industries

- Space
- Aviation
- Medical
- Military
- Petroleum
- Robotics
- Unmanned Systems
- Sensors
- Neuroscience



Durability

Micro 360[®] Circular connectors have the ability to withstand high shock and vibration while maintaining their electrical integrity. The flex pins are capable of over 2,000 mating cycles.



Flexibility

Omnetics' Micro 360[®] series of circular connectors are available with a variety of metal housings and plating options, giving them a reliable environmental seal for harsh environments.

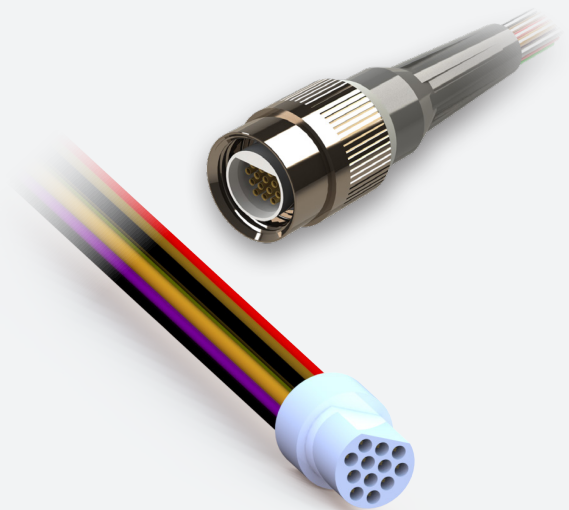

Micro 360® Circular Connectors

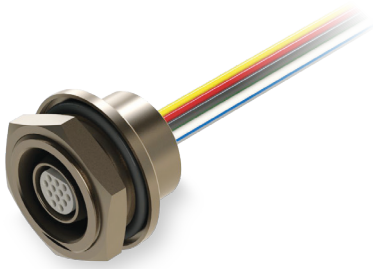

**Micro Metal Twist-Lock Pin
TMCP Series**

- ☑ IP68
- ☑ RoHS
- ☑ 200°C Rated
- ☑ Panel Mount
- ☑ COTS
- ☑ Latches
- ☑ Shielding / Backshell



**Micro Metal Twist-Lock Socket
TMCS Series**

- ☑ IP68
- ☑ RoHS
- ☑ 200°C Rated
- ☑ COTS
- ☑ Shielding / Backshell

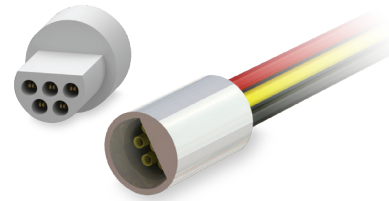

**Micro Plastic Pin/Socket
MCP/MCS Series**

- ☑ RoHS
- ☑ 200°C Rated
- ☑ COTS
- ☑ Latches
- ☑ Plastic Clip Available

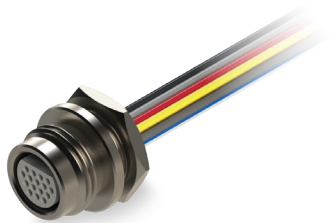

**Micro Metal Threaded Pin
MMCP Series**

- ☑ IP68
- ☑ RoHS
- ☑ 200°C Rated
- ☑ COTS
- ☑ Panel Mount
- ☑ Shielding / Backshell

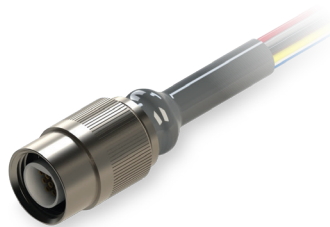

**Micro Metal Threaded Socket
MMCS Series**

- ☑ IP68
- ☑ RoHS
- ☑ 200°C Rated
- ☑ COTS
- ☑ Shielding / Backshell



**Micro Metal Ratcheting Pin
RMCP Series**

- ☑ IP68
- ☑ RoHS
- ☑ Panel Mount
- ☑ COTS
- ☑ Shielding / Backshell



**Micro Metal Ratcheting Socket
RMCS Series**

- ☑ IP68
- ☑ RoHS
- ☑ Panel Mount
- ☑ COTS
- ☑ Shielding / Backshell



**Micro Metal Keyed Break Away Pin
KBMP Series**

- ☑ IP68
- ☑ RoHS
- ☑ 200°C Rated
- ☑ COTS
- ☑ Panel Mount
- ☑ Shielding / Backshell



**Micro Metal Keyed Break Away Socket
KBMS Series**

- ☑ IP68
- ☑ RoHS
- ☑ 200°C Rated
- ☑ COTS
- ☑ Shielding / Backshell

Micro Strip Connectors

Omnetics Micro Strip Connectors are a well-established products in our COTS and Standards family. The ultra-low profile and rugged format are suited to both inside-the-box and board to board solutions.

Omnetics' Micro Strip Connectors are particularly suited to applications where ruggedness is critical, such as in unmanned aerial vehicles which demand rugged performance combined with low weight and small size. Land based robotic circuits have high shock and continuous vibration requirements and contain field replaceable modules that need to be switched quickly.

Product Specifications

Current Carrying:	3 AMPs per contact
Dielectric Withstanding:	600 VAC RMS at Sea Level
Insulation Resistance:	5000 Megohms min at 500 VDC
Vibration:	20 g's with no discontinuities > 1 microsecond
Shock:	50 g's with no discontinuities > 1 microsecond
Operating Temperature:	-55°C - +200°C
Durability:	Exceeds 2000 mating cycles

Industries

- Space
- Aviation
- Medical
- Military
- Petroleum
- Robotics
- Unmanned Systems
- Neuroscience



Durability

Omnetics' rugged lightweight Micro Strip Connectors provide a variety of low profile configurations for demanding applications.



Flexibility

Micro Strip Connectors are available in single row, dual row, and offset dual row configurations with a variety of terminations for PCB and flex termination. Additionally, the rugged lightweight connectors offer a variety of additional securing options.

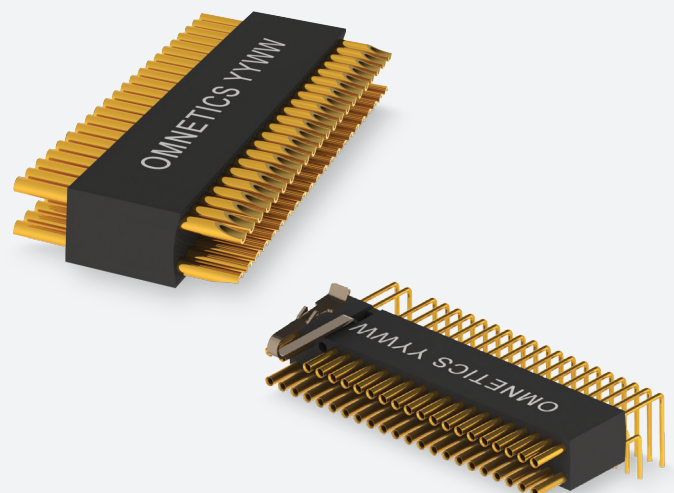

Micro Strip Connectors

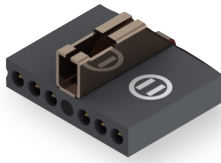

**Micro Single Row Pin
PS1/PS2 Series**

- RoHS
- Guide Posts
- 200 °C Rated
- COTS
- Latches
- Mounting Holes

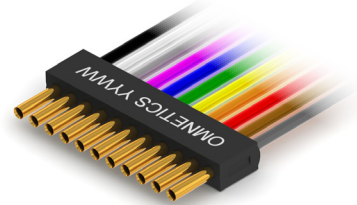

**Micro Single Row Socket
SSB Series**

- RoHS
- Guide Posts
- 200 °C Rated
- COTS
- Latches

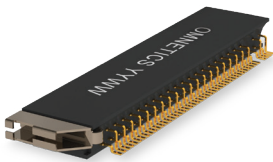

**Micro Dual Row Offset Pin
PSM Series**

- RoHS
- Guide Posts
- 200 °C Rated
- COTS
- Latches
- Mounting Holes



**Micro Dual Row Offset Socket
SSO Series**

- RoHS
- Guide Posts
- 200 °C Rated
- COTS
- Latches
- Mounting Holes

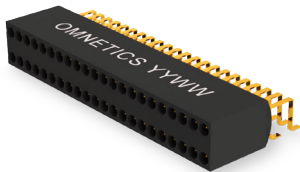

**Micro Dual Row Pin
DRP Series**

- RoHS
- Guide Posts
- 200 °C Rated
- COTS
- Latches



**Micro Dual Row Socket
DRS Series**

- RoHS
- Guide Posts
- 200 °C Rated
- COTS
- Latches
- Mounting Holes

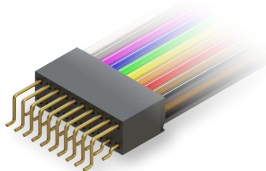

**Micro Header
HMD Series**

- RoHS
- 200 °C Rated
- Mounting Holes
- COTS
- Termination:
 - AA
 - DD
 - H2
 - VV

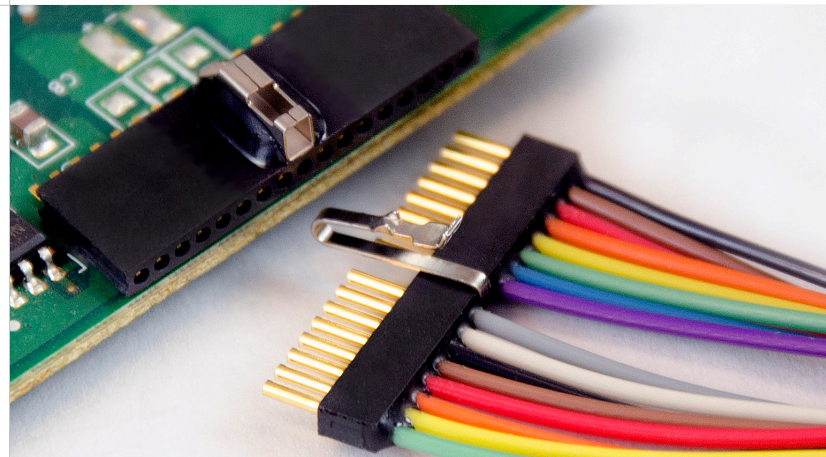

Micro-D Connectors

Omnetics Micro-D, Low Profile Micro-D, and Single Row Micro-D Connectors are ideal for mission critical, high reliability industries including aerospace, military, and down-hole drilling. Omnetics Connector Corporation also offers a tool-free Micro-D equivalent. This Latching Micro-D utilizes the same contact system that Omnetics uses in their QPL

Micro-Ds per MIL-DTL-83513. Even without jackscrews, the performance matches or exceeds the requirements called out in MIL-DTL-83513. The positive latching process quickly mates and de-mates as needed without the use of tools or the need to unscrew fasteners. The operator can simply click it and forget it.

These highly rugged and compact designs are available in shell styles from 9 to 100 contacts.

Product Specifications

Insulator Size:	9 through 100 contacts
Current Carrying:	3 AMPs per contact
Dielectric Withstanding:	600 VAC RMS at sea level
Insulation Resistance:	5000 Megohms min at 500 VDC
Vibration:	20 g's with no discontinuities > 1 microsecond
Shock:	50 g's with no discontinuities > 1 microsecond
Operating Temperature:	-55°C - +260°C
Durability:	Exceeds 2000 mating cycles

Industries

- Space
- Aviation
- Medical
- Military
- Petroleum
- Robotics
- Unmanned Systems



Durability

Micro-D connectors meet or exceed the requirements of MIL-DTL-83513. In addition to a variety of termination styles for PCB and flex terminations, there are configurations available with QPC.



Flexibility

Omnetics' Micro-D connectors not only offer traditional jack-screw/jack-post configurations, but are also available in a tool-free latching configuration.

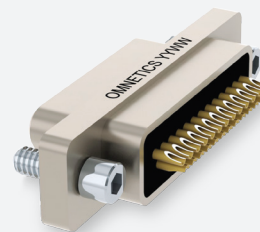

Micro-D Connectors

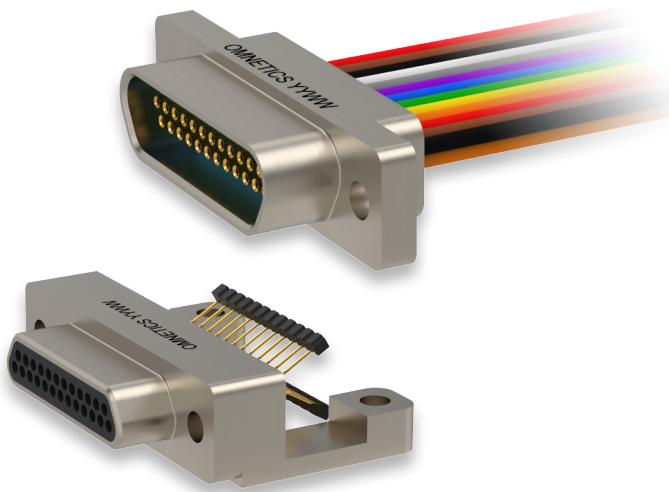

Standard Micro-D Pin/Socket MMDP/MMDS Series

- RoHS
- 260 °C Rated
- Mounting Holes
- COTS
- Panel Mount
- Shielding / Backshell

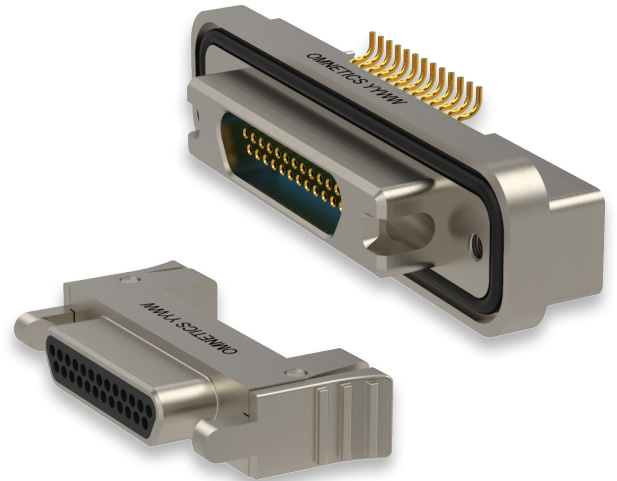

Latching Micro-D Pin/Socket LMDP/LMDS Series

- RoHS
- 260 °C Rated
- Mounting Holes
- COTS
- Latches
- Shielding / Backshell

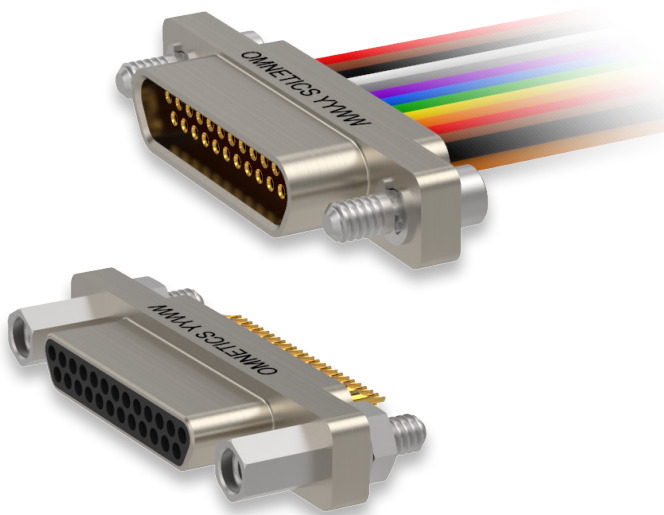

Low Profile Micro-D Pin/Socket MDLP/MDLS Series

- RoHS
- 260 °C Rated
- COTS
- Mounting Holes
- Shielding / Backshell

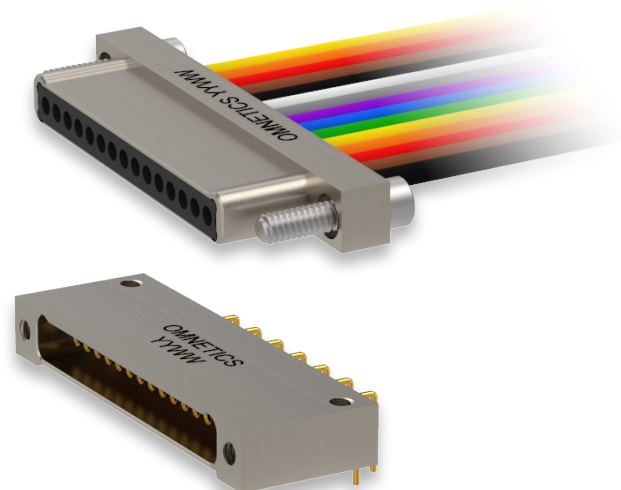

Single Row Micro-D Pin/Socket MMPS/MMSS Series

- RoHS
- 200 °C Rated
- COTS
- Latches
- Shielding / Backshell

Hybrid Connectors

Omnetics Connector Corporation offers a range of hybrid connector options allowing designers the ability to transmit data, signals, and power easily in a single connector footprint. These new connector families are an ideal solution for designers looking to upgrade as it relates to not only the size, but the overall performance of their miniature rugged devices. Omnetics Hybrid series allow the designers themselves the ability to determine the amount of signal and power connections that best serve their particular application. These Hybrid configurations are available in Micro-D, Nano-D and Micro Circular footprints.



Industries

- Space
- Aviation
- Medical
- Military
- Petroleum
- Robotics
- Unmanned Systems

Options

- IP68
- RoHS
- Panel Mount
- Latches
- Shielding / Backshell
- High Speed



Why Omnetics?

Omnetics' rugged hybrid connectors offer a variety of configurations allowing you to reduce the number of connectors on a device while meeting your power requirements.



Why a Hybrid Connector?

Rugged hybrid connectors allow you to meet the signal integrity requirements for your high speed digital data, reduce size and weight, and maintain power.



Hybrid and High-Speed Connectors

Micro-D Hybrid

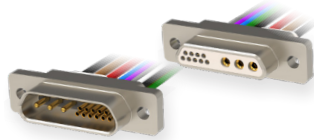

Insulators Sizes:	9 through 51 contacts
Dielectric Withstanding:	600 VAC RMS at Sea Level (Power contacts) 1000 VAC RMS at Sea Level (Micro contacts)
Insulation Resistance:	5000 Megohms min at 500 VDC
Vibration:	20 g's with no discontinuities > 1 microsecond
Shock:	50 g's with no discontinuities > 1 microsecond
Contact System:	Contact Omnetics for options and specifications
Operating Temperature:	-55°C to +125°C
Durability:	500 mating cycles

Nano-D Hybrid



Insulators Sizes:	12 through 39 contacts
Dielectric Withstanding:	250 VAC RMS at Sea Level (Nano contacts) 1000 VAC RMS at Sea Level (Micro contacts)
Insulation Resistance:	5000 Megohms min at 100 VDC (Nano contacts) 5000 Megohms min at 500 VDC (Micro contacts)
Vibration:	20 g's with no discontinuities > 1 microsecond
Shock:	100 g's with no discontinuities > 1 microsecond
Contact System:	Qualified to MIL-DTL-83513 & 32139 (QPL for wired & soldercups)
Operating Temperature:	-55°C to +200°C
Durability:	Exceeds 2000 mating cycles

Circular Hybrid

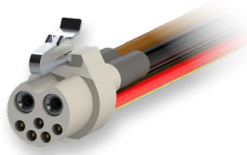

Insulators Sizes (Micro Circulars):	12 through 39 contacts
Dielectric Withstanding:	600 VAC RMS at Sea Level
Insulation Resistance:	5000 Megohms min at 500 VDC
Vibration:	20g's with no discontinuities > 1 microsecond
Shock:	50g's with no discontinuities > 1 microsecond
Contact System:	Contact Omnetics for options and specifications
Operating Temperature:	-55°C to +125°C
Durability:	500 mating cycles

Circular USB 3.0



Data Rate:	Up to 5 Gbps
Impedance:	90 ± 15 Ω
Insertion Loss:	-3.0 dB Max @ 2.5 GHz
Dielectric Withstanding:	600 VAC RMS at Sea Level
Insulation Resistance:	5000 Megohms min at 500 VDC
Sealing Performance:	IP68
Operating Temperature:	-55°C to +85°C
Durability:	Exceeds 2000 mating cycles

High-Speed Nano-D

High Density (HS2) Mated Performance

Matings	Horizontal Surface Mount (AA)	Vertical Surface Mount (VV)
6" Jumper	13 Gbps	20 Gbps
18" Jumper	10 Gbps	14 Gbps

* Test reports available upon request

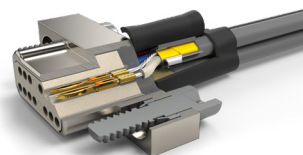

High Performance (HS3) Mated Performance

Matings	Horizontal Surface Mount (AA)	Vertical Surface Mount (VV)
6" Jumper	17 Gbps	20 Gbps
18" Jumper	16 Gbps	17 Gbps

* Test reports available upon request

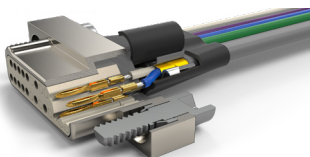

USB-C



Nano 360[®] Circular Connectors

At .025" pitch, Omnetics Nano 360[®] Circular connectors are the smallest mil-aero circular connectors on the market. Compared to larger circular configurations, we have reduced the size and weight by as much as 3x compared to standard .050" pitch circular connectors. Omnetics Nano 360[®] Circular connectors offer a number of standard designs and locking methods with pin counts ranging from 2 to 39 positions. The unique polarized-insulator allow for both plastic and metal shell connector design styles. Threaded couplings, metal and plastic breakaway shells and twist-lock housings are ready for both inline as well as panel mount interconnections. Thirty-two gauge standard Teflon insulated copper wire is also offered from stock that handles nearly 1 ampere of current per contact.

Product Specifications

(excludes Nano IP68 Circular Series)

Insulator Sizes:	6 through 39 contacts
Current Carrying:	1 AMP per contact
Dielectric Withstanding:	250 VAC RMS at sea level
Insulation Resistance:	5000 Megohms min at 100 VDC
Vibration:	20 g's with no discontinuities > 10 nanoseconds
Shock:	100 g's with no discontinuities > 10 nanoseconds
Operating Temperature:	-55°C - +200°C
Durability:	Exceeds 2000 mating cycles

Industries

- Space
- Aviation
- Medical
- Military
- Petroleum
- Robotics
- Unmanned Systems
- Sensors
- Neuroscience



Durability

The Nano 360[®] Circular connectors have the ability to withstand high shock and vibration while maintaining their electrical integrity. The flex pins are capable of over 2,000 mating cycles.



Flexibility

Omnetics' Nano 360[®] Circular connectors are available with a variety of metal housings and plating options which giving them a reliable environmental seal for harsh environments.



Nano 360® Circular Connectors

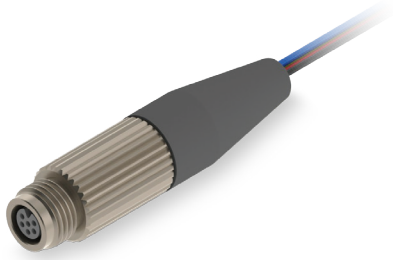

**Nano Metal Threaded Pin
MNCP Series**

- ☑ IP68
- ☑ RoHS
- ☑ 200 °C Rated
- ☑ COTS
- ☑ Panel Mount
- ☑ Shielding / Backshell

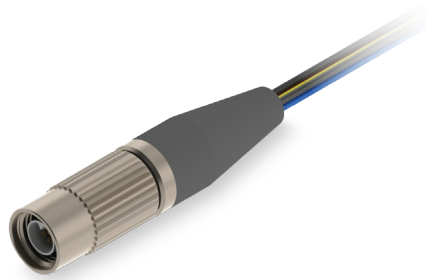

**Nano Metal Threaded Socket
MNCS Series**

- ☑ IP68
- ☑ RoHS
- ☑ 200 °C Rated
- ☑ COTS
- ☑ Shielding / Backshell

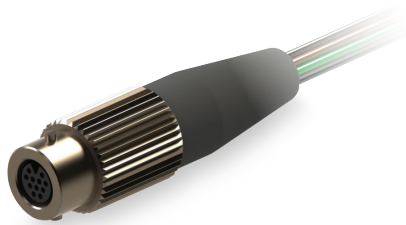
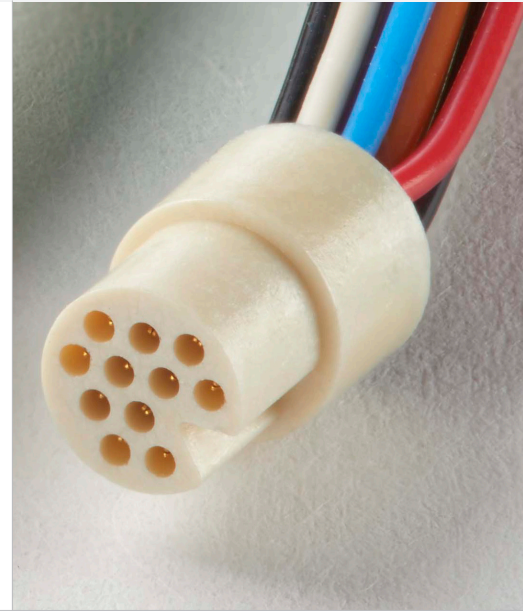

**Nano Metal Twist-Lock Pin
TNCP Series**

- ☑ IP68
- ☑ RoHS
- ☑ 200 °C Rated
- ☑ COTS
- ☑ Panel Mount
- ☑ Shielding / Backshell

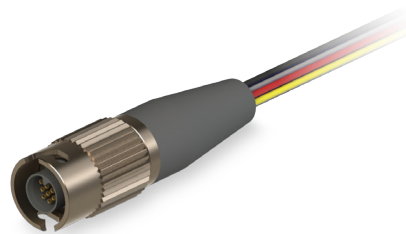

**Nano Metal Twist-Lock Socket
TNCS Series**

- ☑ IP68
- ☑ RoHS
- ☑ 200 °C Rated
- ☑ COTS
- ☑ Shielding / Backshell

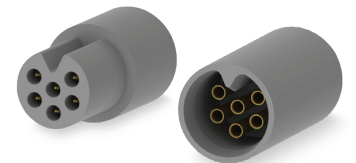

**Nano Plastic Pin/Socket
NCP/NCS Series**

- ☑ RoHS
- ☑ 200 °C Rated
- ☑ COTS
- ☑ Plastic Clip



**Nano Metal Keyed Break Away Pin
KBNP Series**

- ☑ IP68
- ☑ RoHS
- ☑ 200 °C Rated
- ☑ COTS
- ☑ Panel Mount
- ☑ Shielding / Backshell



**Nano Metal Keyed Break Away Socket
KBNS Series**

- ☑ IP68
- ☑ RoHS
- ☑ 200 °C Rated
- ☑ COTS
- ☑ Panel Mount
- ☑ Shielding / Backshell

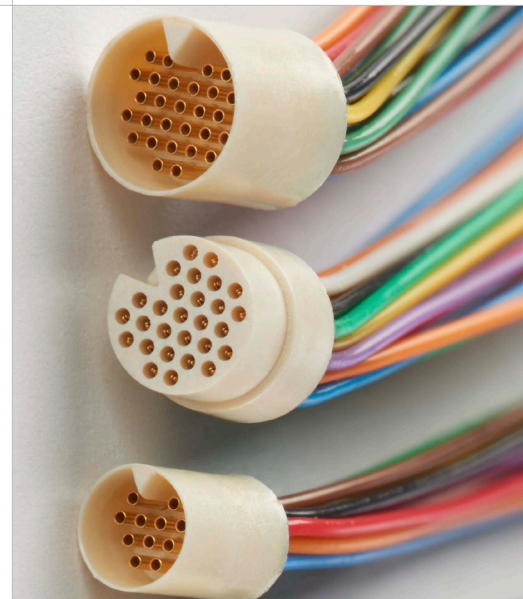

Nano Strip Connectors

Omnetics Nano Strips and PZN series are an ideal solution for designers who are tight for space, yet demand rugged reliability. Omnetics Polarized Nano Series is a hermaphroditic connector solution encompassing both male and female contacts within the same insulator arrangement. Benefits from this connector configuration include the fact the connector itself is polarized, thus eliminating the need for excess weight caused by guide pins or other polarizing features. Meanwhile, at .025" (.64 mm) spacing, both product families offer mil quality, gold plated contacts for the reliability you need.

Product Specifications

(excludes PZN series)

Current Carrying:	1 AMP per contact
Dielectric Withstanding:	250 VAC RMS at Sea Level
Insulation Resistance:	5000 Megohms min at 100 VDC
Vibration:	20 g's with no discontinuities > 10 nanoseconds
Shock:	100 g's with no discontinuities > 10 nanoseconds
Operating Temperature:	-55°C - +200°C
Durability:	Exceeds 2000 mating cycles

Industries

- Space
- Aviation
- Medical
- Military
- Petroleum
- Robotics
- Unmanned Systems
- Sensors



Durability

Nano Strip connectors provide a rugged, low profile, and lightweight option to reduce the size and weight of the interconnect in applications. These connectors exceed 2,000 mating cycles.



Flexibility

Omnetics' Nano Strip connectors are available in a variety of configurations and termination styles for PCB and flex terminations.

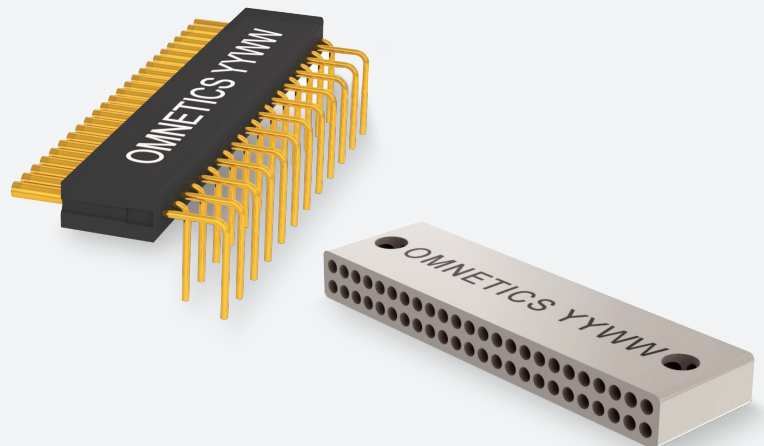

Nano Strip Connectors

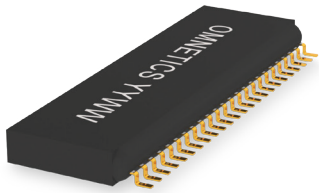

**Nano Single Row Pin
NPS Series**

- RoHS
- 200 °C Rated
- Guide Pins
- COTS
- Mounting Holes

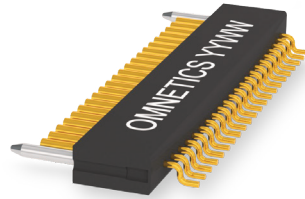

**Nano Single Row Socket
NSS Series**

- RoHS
- 200 °C Rated
- Guide Pins
- COTS

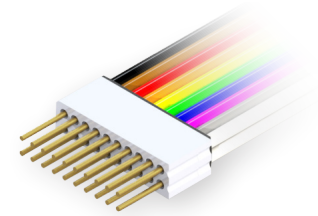

**Nano Header
HND Series**

- RoHS
- 200 °C Rated
- COTS
- Termination:
 - AA
 - DD
 - H2
 - VV

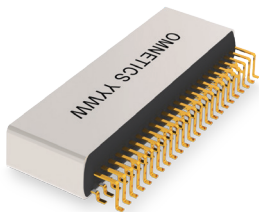

**Nano Dual Row Pin
NPD Series**

- RoHS
- 200 °C Rated
- Guide Pins
- COTS
- Latches
- Mounting Holes

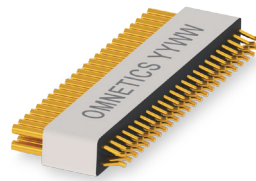

**Nano Dual Row Socket
NSD Series**

- RoHS
- 200 °C Rated
- Guide Pins
- COTS
- Latches

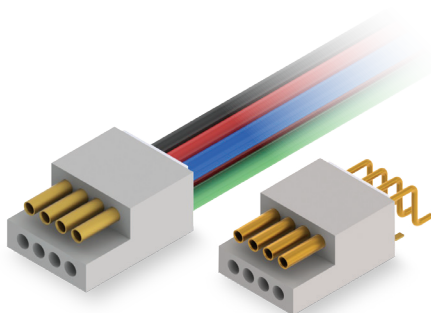
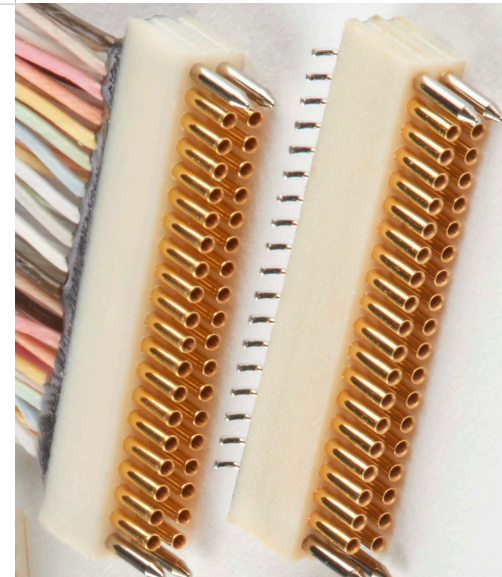

**Polarized Nano
PZN Series**

- RoHS
- 200 °C Rated
- COTS

Product Specifications

Current Carrying	1 AMP per contact
Dielectric Withstanding	250 VAC RMS at Sea Level
Insulation Resistance	5000 Megohms min at 100 VDC
Vibration	20 g's with no discontinuities > 10 nanoseconds
Shock	100 g's with no discontinuities > 10 nanoseconds
Operating Temperature	-55°C - +200°C
Durability	Exceeds 500 mating cycles

Bi-Lobe® / Nano-D Connectors

Omnetics Bi-Lobe® / Nano-D connectors, at .025” pitch, are some of the smallest most rugged connectors on the market today. Omnetics has reduced size and weight by as much as 4x that of standard Micro-D connectors and 8x that of previous D-Sub footprints. These ultra-miniature connectors, like all of Omnetics connectors, use our unique flex-pin gold plated contacts that are polarized and shrouded by a unique liquid crystal polymer insulator and “lobed” housing making these connectors capable of over 2,000 mating cycles. Omnetics space grade connectors are available in a number of tail terminations. Standard pre-wired connectors come in 18” and 36” lengths with 80 micro inches of silver plated 30 AWG (7-38) PTFE insulated wire. Board mount options include both surface mount as well as thru-hole. If you are using a flex circuit, flex tails are also available.

Product Specifications

Current Carrying:	1 AMP per contact
Dielectric Withstanding:	250 VAC RMS at Sea Level
Insulation Resistance:	5000 Megohms min at 100 VDC
Vibration:	20 g's with no discontinuities > 10 nanoseconds
Shock:	100 g's with no discontinuities > 10 nanoseconds
Operating Temperature:	-55°C - +200°C
Durability:	Exceeds 2000 mating cycles

Industries

- Space
- Aviation
- Medical
- Military
- Petroleum
- Robotics
- Unmanned Systems
- Sensors



Durability

The Bi-Lobe® / Nano-D connectors meet or exceed the requirements of MIL-DTL-32139. This connector will also exceed 2,000 mating cycles.



Flexibility

In addition to a variety of termination styles for PCB and flex termination, Omnetics offers configurations available with QPL.

Omnetics' Bi-Lobe® / Nano-D connectors not only offer traditional jack-screw/jack-post configurations but are also available in a tool free latching configuration.

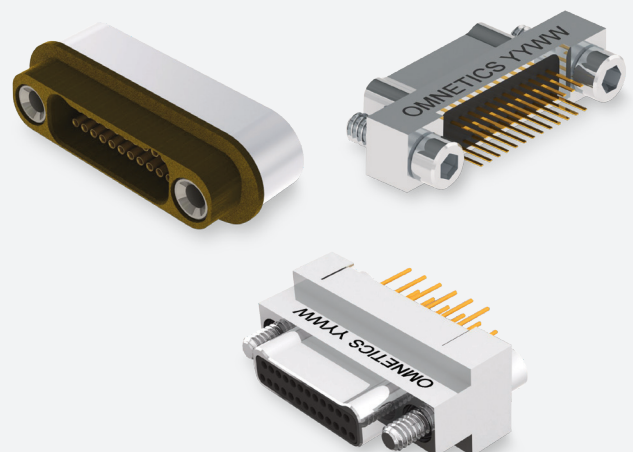

Bi-Lobe® / Nano-D Connectors

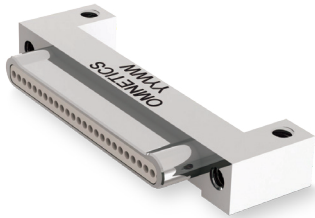

**Nano-D Single Row Pin
MBPS Series**

- RoHS
- 200°C Rated
- COTS
- Mounting Holes
- Shielding / Backshell

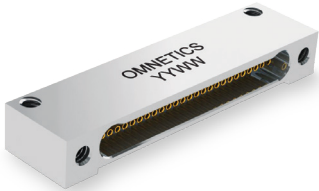

**Nano-D Single Row Socket
MBSS Series**

- RoHS
- 200°C Rated
- COTS
- Mounting Holes
- Shielding / Backshell

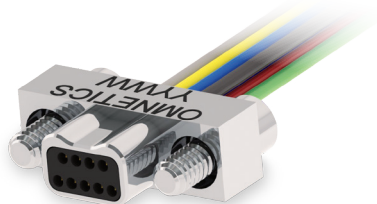

**Nano-D Dual Row Pin
MNPO Series**

- RoHS
- 200°C Rated
- COTS
- Latches
- Shielding / Backshell



**Nano-D Dual Row Socket
MNSO Series**

- RoHS
- 200°C Rated
- COTS
- Mounting Holes
- Shielding / Backshell

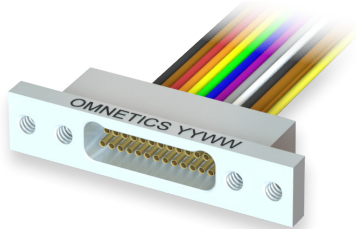

**Nano-D Dual Row Panel Mount
MNSOP Series**

- RoHS
- 200°C Rated
- COTS
- Mounting Holes
- Shielding / Backshell



**Nano-D Dual Row Latching Panel Mount Socket
MNSLP Series**

- RoHS
- 200°C Rated
- COTS
- Mounting Holes
- Shielding / Backshell



**Nano-D Dual Row Latching Pin
MNPL Series**

- RoHS
- 200°C Rated
- COTS
- Latches
- Shielding / Backshell



**Nano-D Dual Row Latching Socket
MNSL Series**

- RoHS
- 200°C Rated
- COTS
- Mounting Holes
- Shielding / Backshell

Specification Sheets

Space Level Screening

Per EEE-INST-002



Ordering Steps

Step 1 - Choose a suitable Micro or Nano connector

Step 2 - Choose a level of Space Screening

Level 1 - Mission Critical (Highest Reliability)

Level 2 - High Reliability

Level 3 - Standard Reliability

Step 3 - Select any added outgassing processing needed.

Step 4 - Specify chosen ORDERING CODES from table below.
These codes should be used as separate line items on all quote Requests and Purchase Orders as required.

Ordering Codes (quoted as separate line items)

Screening Level	Special Screening Only	Processing for Outgassing
Level 1 - Mission Critical	SPT1	All standard materials exhibit less than 1.0% TML without additional processing. Contact service for special requirements.
Level 2 - High Reliability	SPT2	
Level 3 - Standard Reliability	Standard	

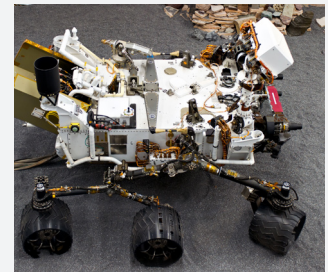

Inspection/Test	Micro (.050" center)		Nano (.025" center)	
	Level 1 Com'l/SCD	Level 2 Com'l/SCD	Level 1 Com'l/SCD	Level 2 Com'l/SCD
Visual	100%	100%	100%	100% 100%
Mechanical	2 (0)	2 (0)	2 (0)	2 (0)
Voltage Rating (DWV)	100%	2 (0)	100%	2 (0)
Insulation Resistance	2 (0)	2 (0)	2 (0)	2 (0)
Temperature Cycling	2 (0)	2 (0)	2 (0)	-
Low Level Contact Resistance	2 (0)	2 (0)	2 (0)	2 (0)
Mating/Unmating Force	2 (0)	-	2 (0)	-
Solderability/Resistance to heat (SMT & Thru-Hole only)	2 (0)	-	2 (0)	-

Note: NASA screening requirements from Table 2C & 2J of EEE-INST-002

Backshell and Assembly Options

Backshells

Omnetics manufactures a selection of Micro-D and Nano-D backshells commonly used for mission critical applications. These small lightweight accessories will provide strain relief to the wires or cable. This prevents mechanical stress and aids in the shielding technology to ensure EMC of the interconnect systems. Backshells are available in many different form factors for flexibility and added strain relief.

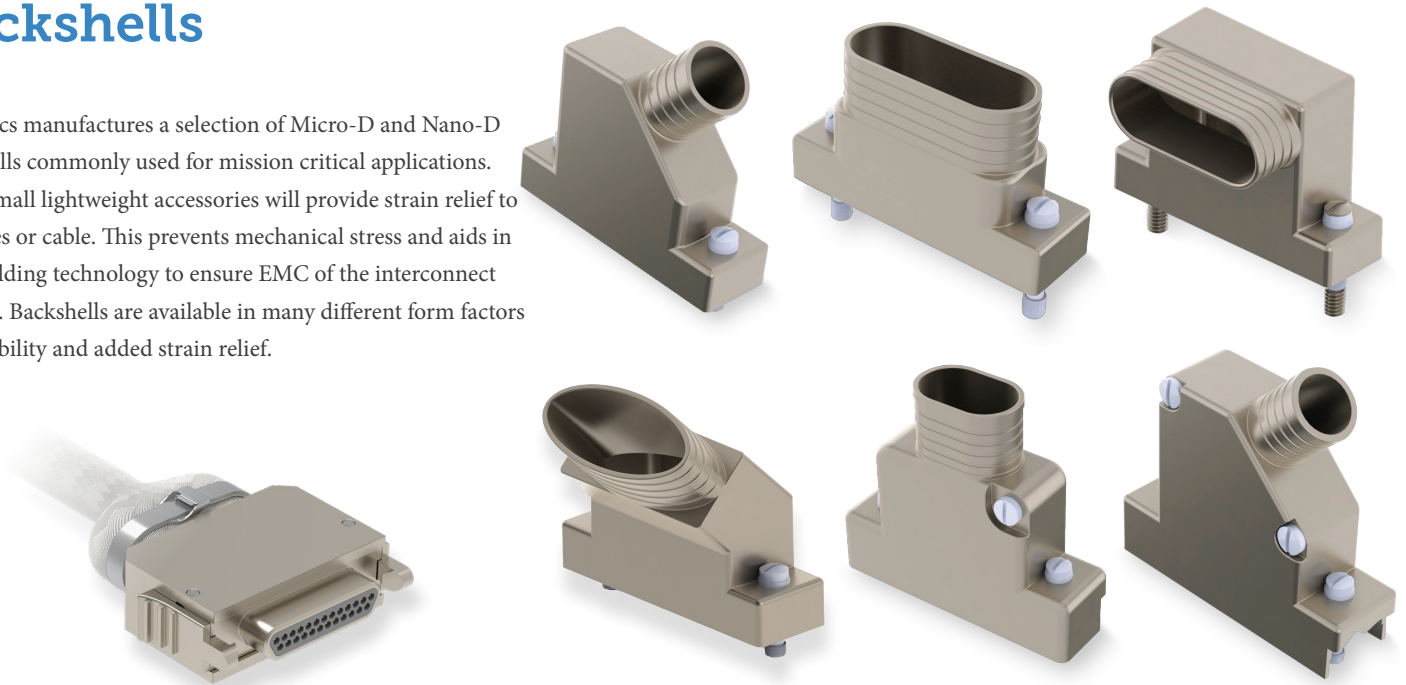

Cable Assembly and Wire Harness

Omnetics manufactures a wide range of cable and wire harness assemblies for Nano and Micro miniature form factors. These assemblies are built to meet or exceed the durability and performance requirements of the application environment. Omnetics is well suited to meet the cable harness needs of our customers, with IPC-610 and IPC-620 trained workers on-site. Our experienced staff of sales, engineering, and manufacturing professionals make cable harness projects a hassle-free experience.



High Speed Protocol

	Camera Link	GigE Ethernet	10 GigE Ethernet	HDMI	USB 3.0
Micro-D					
Nano-D					
Micro Strip					
Nano Strip					
Micro Circular					
Nano Circular					

High Speed Digital Connectors

Today's design engineers have a strong directive when it comes to military electronics, and much of the emphasis is focused heavily around SWaP (Size, Weight and Power). The main challenge when designing SWaP-optimized electronics is finding the delicate balance between size, weight, and power consumption, without physically compromising the devices' overall performance, durability, and reliability. Many advanced avionics platforms today are processing mountains of data, and in doing so, are consuming more power than ever before. This requires today's engineers to design embedded electronics and interconnect systems differently, so they can handle increased data speeds and bandwidth without adding significant weight. Omnetics Connector Corporation has been able to lend their expertise to this issue by releasing a new set of miniaturized high-speed standards featuring ruggedized HDMI and Cat6a Ethernet connector offerings. This new family of miniature circulars allows designers the ability to transmit uninterrupted, high-speed digital signals in some of the smallest Mil-spec footprints on the market.

Cat6a Ethernet Micro



Cat6a Ethernet Nano



HDMI Nano



Precision Machining Division

Omnetics' expanding Precision Machining Division allows us to continue to meet the growing opportunities and demands of our customers in the Military, Aerospace, Satellite, Petroleum, and Medical markets. This additional capacity allows us to meet and exceed our customers' expectations for service, quality and on time delivery. We continue to invest in new, high technology machining to reduce scrap, cost, setup time, and lead time. New Swiss machines also expand our capabilities and allow us to manufacture new, customized products that can be designed and completed in just a few simple steps.



www.omneticsprecision.com

OMNETICS

CONNECTOR CORPORATION



SPACE

Missile Warning
SATCOM
PNT Signals
ISR



COMMAND

GPS Guided Artillery
IR Guided Missiles
High Power Microwaves

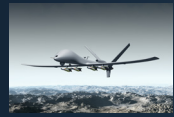

AIR

IO Broadcast
Radar EA
IFF Signals



WATER

Radar Guided Missiles
RF Sensors
Laser Comms



LAND

Tracking Radars
Laser Dazzler
Laser Guided Munition

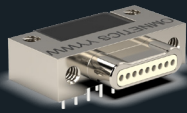
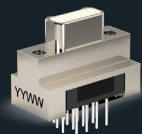
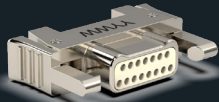
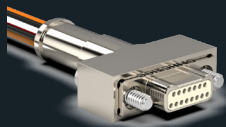
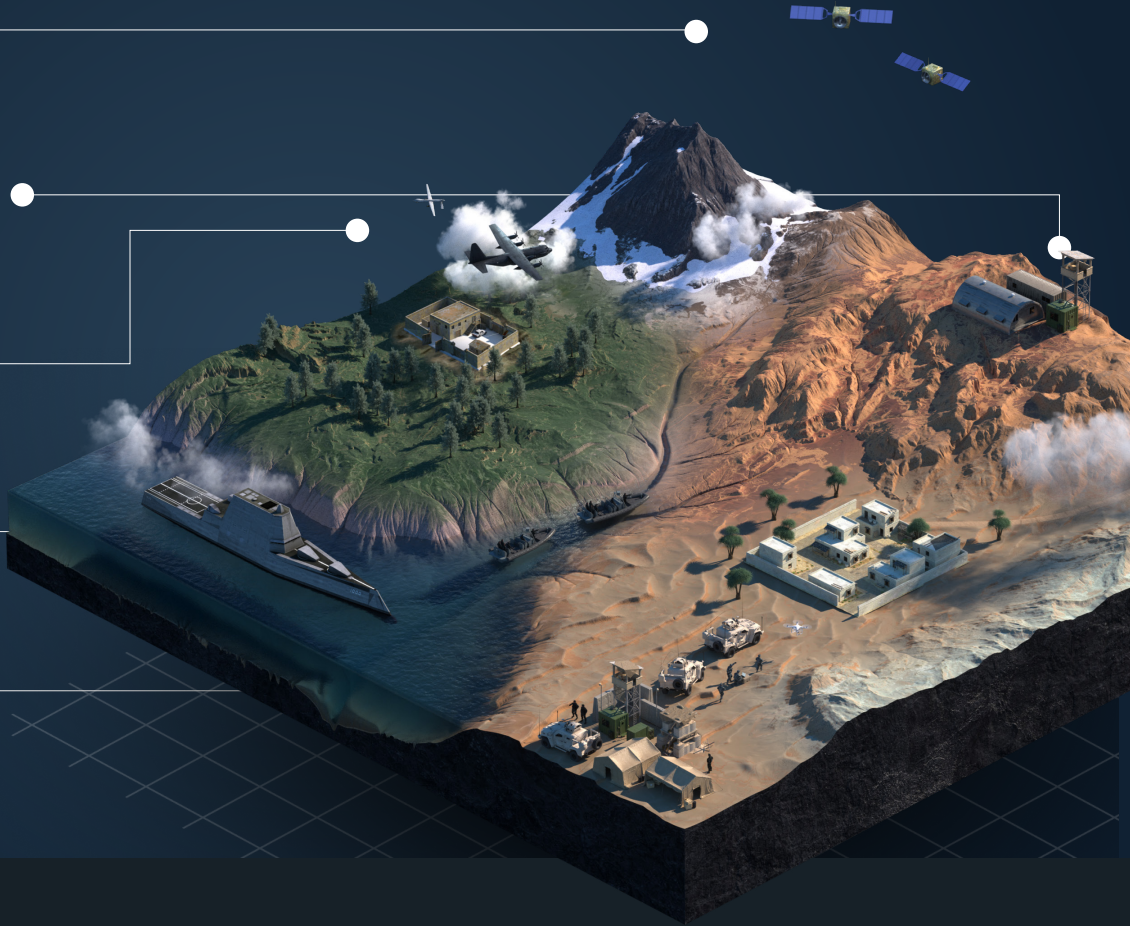

Ruggedized nano-miniature interconnect solutions for high reliability applications.

Omnetics' connectors are proven to deliver exceptional performance in extreme environments for mission-critical applications.



OMNETICS

CONNECTOR CORPORATION

Omnetics Connector Corporation is a worldwide designer and manufacturer of Micro and Nano miniature interconnect products, featuring COTS, Standards and Custom connectors for industries such as the Military, Aerospace, Defense, Medical and other Technology oriented OEMS.

sales@omnetics.com

Ph: +1 763-572-0656 | F: 763-572-3925



© 2025 Omnetics Connector Corporation
Minneapolis, MN, USA
www.omnetics.com